



**Convergence on graphic representations of
designs - Common Communication**
15 May 2018

1. BACKGROUND

The IP Offices of the European Trade Mark and Design Network continue to collaborate in the context of the Convergence Programme. They have now agreed on the first Common Practice of Designs with the aim of giving guidance for the examination procedures on how to use the appropriate disclaimers, types of views and how to represent designs in a neutral background. Furthermore, there is also an overview of the Offices' quality standards for design applications received by electronic means and by paper.

This Common Practice is made public through this Common Communication with the purpose of further increasing transparency, legal certainty, and predictability for the benefit of examiners and users alike.

The following issues are out of the scope of the project:

- Verbal disclaimers.
- Additional elements (not all the Offices consider additional elements to be within the Neutral Background concept).
- Priority (not all the Offices carry out an examination of priority claims).
- Disclosure (not all the Offices have invalidity proceedings).
- Number of views (a large number of Offices have legal constraints).
- Computer-animated representations, 3D representations (a large number of Offices have legal constraints).

2. THE COMMON PRACTICE

The following text summarizes the key messages and the main statements of the principles of the Common Practice. The complete text and all the examples used to illustrate the common criteria can be found in Annex 1. The results of a benchmarking study on the quality standards required for applications received by electronic means and by paper can be found at the end of Annex 1.

The images should be of good quality and capable of reproduction. In order to determine the requirements of a correct graphic representation of designs, the following criteria are considered:

WITH RESPECT TO THE USE OF VISUAL DISCLAIMERS

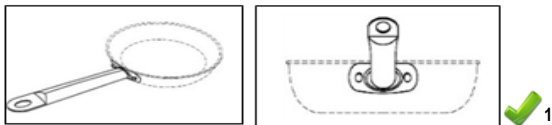
| | |
|----------------------------|---|
| <p>Definition</p> | <p>Visual disclaimers indicate that protection is not being sought for, and registration has not been granted for, certain features of the design shown in the representation. Thus, they indicate what is not intended to be protected.</p> |
| <p>Requirements</p> | <p>Visual disclaimers will only be accepted when:</p> <ul style="list-style-type: none"> • They clearly indicate that protection is not being sought for certain features of the design shown in the representation. • They are shown consistently in all the views where the disclaimer appears. <div style="text-align: center;">  <p>RCD No. 002322644-0001 (07.02) (pan handles) Owner: ACTERVIS, GMBH</p> </div> |

¹ For the sake of clarity, the examples indicated with a "✔" are acceptable and the examples indicated with a "✘" are not acceptable.

**Recommendations/
Guidelines**

Graphic or photographic representations showing only the claimed design are preferred.

However, disclaimers can be used when the graphic or photographic representation of the design contains parts of the product for which no protection is sought. In these cases, the disclaimer must be clear and obvious: the claimed and disclaimed features must be clearly differentiated.

Where a disclaimer is used, **broken lines are recommended**. Only when broken lines cannot be used due to technical reasons (for example, when they are used to indicate stitching on clothing or patterns; or photographs are used), other disclaimers can be used: colour shading, boundaries and blurring.

a) Broken lines

If a disclaimer is used, broken lines are **recommended**. They are used to indicate that no protection is sought for the features that are shown using the interrupted trace.

In order to be accepted, the features for which protection is not sought should be clearly indicated with broken lines, whereas the parts for which protection is sought should be indicated with continuous lines.

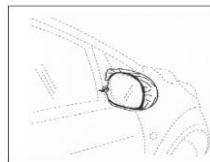

BX registered design No. 38212-0001 (12.16)
(Rearview mirrors) Owner: Interimage BV

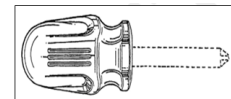

Hungarian registered design No. D9900409-0001
(08.04) (handle of screwdriver)
Owner: Cooper Industries, Inc.

When broken lines are a feature of the design and a part of the design needs to be disclaimed, other visual disclaimers can be used.

b) Colour shading

Although broken lines are the preferred disclaimer, if they cannot be used, the use of colour shading could be an option. This type of visual disclaimer consists of using contrasting tones of colour to obscure sufficiently the features for which protection is not being sought.

The features for which protection is sought must be clearly shown so that they are neatly perceptible, whereas the disclaimed features must be represented in a different tone of colour and in a way that they appear blurred or imperceptible.



RCD No. 000910146-0004 (12.08) (Automobiles (part of-))
Owner: TOYOTA MOTOR CORPORATION

c) Boundaries

Although broken lines are the preferred disclaimer, if they cannot be used, the use of boundaries could be an option. With this type of visual disclaimer, the features for which

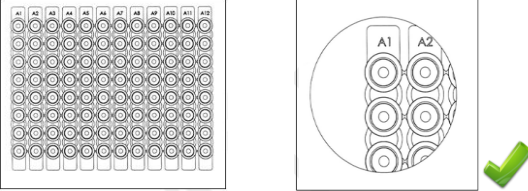
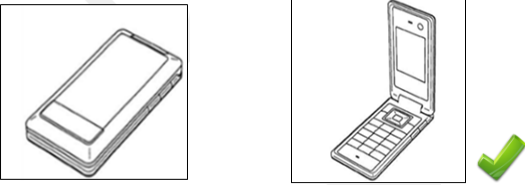
| | |
|--|--|
| <p>Guidelines for each type of view:</p> | <p>The use of aspect views to disclose the features of the design is preferred. However, the applicant is free to provide complementary/additional views as mentioned above. Therefore:</p> |
| <p>a) Aspect views</p> | <p>Show the design from certain directions (angles) and encompass the following views: front view, top view, bottom view, right side view, left side view, back view and perspective views. The applicant is recommended to file as many views as necessary to fully disclose the features of the design. In some cases one view can be sufficient.</p>  <p>RCD No. 002325456-0001 (31.00) (Mixers, electric [kitchen]) Owner: KENWOOD LIMITED</p> |
| <p>b) Views magnifying part of the design</p> | <p>Show one part of an overall design in an enlarged scale.</p> <p>A single magnified view is acceptable provided that the magnified part is already visible in one of the other submitted views and it is presented in a separate single view.</p>  <p>RCD No. 001913690-0002 (24.02) (PCR multi-well plates) Owner: ABGENE LIMITED</p> |
| <p>c) Alternate positions</p> | <p>Designs with alternate positions have an appearance which can be modified into several configurations without any addition or removal of any parts.</p> <p>The views showing the different configurations of the design must be shown separately.</p>  <p>RCD No. 000588694-0012 (14.03) (Mobile phones) Owner: Fujitsu Mobile Communications Limited</p> |

d) Exploded views

Views where the parts of a product are shown disassembled in order to clarify how the parts fit together.

These views must be combined with at least one view representing the product assembled. All the parts of a product must be shown disassembled in a separate single view, in close proximity and in order of assembly.

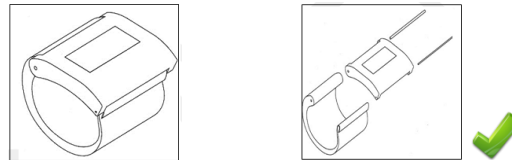

Croatian registered design No. D20140080 (24.01) (Bracelets with muscle stimulator) Owner: Dominik Žinić

Note: Showing the exploded parts in an additional view can help to facilitate the understanding of the design. However, only the parts that remain visible during the normal use of the product are protected.

e) Partial views

Show a part of a product in isolation.

Partial views can be magnified and must be combined with at least one view representing the product assembled.



RCD No. 2038216-0001 (15.01, 23.04) (Air filters, Containers for air filters, for engines) Owner: BMC S.r.l.

f) Sectional views

Cutaway portions that complement aspect views by illustrating a feature or features of the appearance of the product such as the contour, surface, shape or configuration of the product.

Sectional views should, in an unambiguous way, be a view of the same design and must be submitted with other traditional views such as aspect views. It should be noted that representations with technical indications such as axial lines or sizes (dimensions), numbers are not allowed.

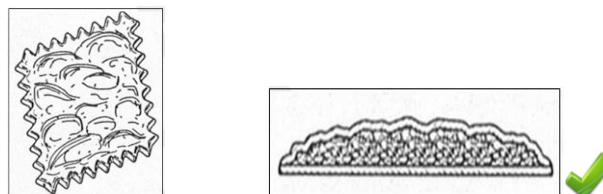

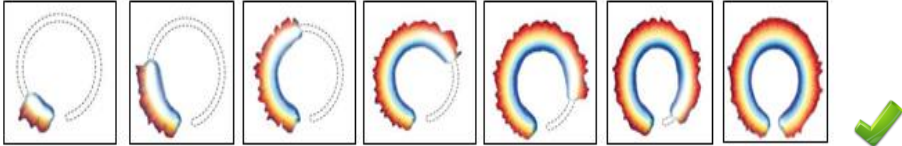
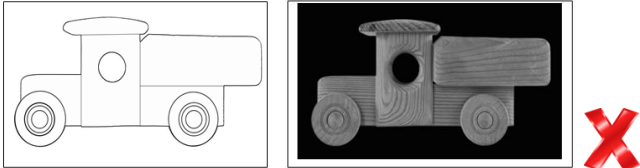

Spanish registered design No. I0152702-D (01.01) (biscuits) Owner: CUETARA, S.L.

Note: Adding sectional views can help to facilitate the understanding of the design. However, only the parts that remain visible during the normal use of the product are protected.

| | |
|--|--|
| <p>g) Sequence of snapshots (animated designs)</p> | <p>Short sequence of views used to show a single animated design at different specific moments in time, in a clearly understandable progression. This applies to an animated icon (design consisting of a sequence) or an animated graphical user interface (design of an interface). In order to be accepted:</p> <p>The sequence of snapshots needs to be visually related (must have features in common) and it is the responsibility of the applicant to number the views in such a way so as to give a clear perception of the movement/progression.</p>  <p>RCD No 2085894-0014 (14.04) (Animated screen displays) Owner: NIKE Innovate C.V.</p> |
| <p>h) Combination of several means of visual representation</p> | <p>It is recommended that a design should be represented using only one visual format (drawing, photograph) so as to avoid disclosing aspects that contribute to a different overall impression.</p> <p>Where multiple representations of a design are used, each must clearly and obviously relate to the same design and be consistent when comparing the features disclosed.</p>  <p>CP6 Example (21.01) (Vehicles [toys])</p> |

WITH RESPECT TO THE NEUTRAL BACKGROUND

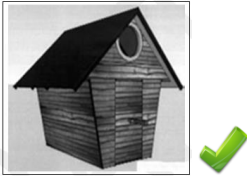
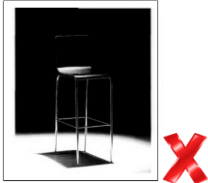
| | |
|--|---|
| | <p>In order to assess if a background is neutral, the following aspects should be taken into consideration:</p> |
| <p>a) Requirements related to colours</p> | <ul style="list-style-type: none"> • A single or predominant colour in a background is always acceptable if it stands out against the colours of the design. • Graduating colour and more than one colour in a background is acceptable if the design is clearly distinguishable.  <p>Austrian lapsed design No. 1747/1999 (01.01) (Ice lolly) Owner: Schöller Lebensmittel GMBH & O. KG</p> <p>French registered design No. 955805-0005 (09.07) (Cover for perfume bottle) Owner: SNIC SARL</p> <p>CP6 Example (01.01) (Cakes)</p> |

| | |
|---|---|
| <p>b) Requirements related to contrast</p> | <ul style="list-style-type: none"> All features of the design should be clearly visible. The contrast is considered insufficient when the colour of the background and the design are similar and partly melt into each other (i.e. it is not clear where the product finishes and the background starts). Sometimes a darker background can help when the design is clear or pale and vice-versa. <div style="display: flex; justify-content: space-around; align-items: flex-end;"> <div style="text-align: center;">  <p>BX registered design No. 38895-00 (25.03) (Shed) Owner: Herman Lankwarden</p> </div> <div style="text-align: center;">  <p>Portuguese lapsed design No. 420-0006 (06.01) (chairs) Owner: Abril Mobiliário</p> </div> </div> |
| <p>c) Requirements related to shadows/ reflections</p> | <ul style="list-style-type: none"> Shadows or reflections are acceptable as long as all features of the design remain visible. Shadows or reflections are unacceptable when the subject of protection of the design, in any of the submitted views, cannot be determined in an unambiguous way. This can occur when there is limited colour contrast with the design, and/or shadows interfere with, or hide parts of, the design or they distort the contour of the design. <div style="display: flex; justify-content: space-around; align-items: flex-end;"> <div style="text-align: center;">  <p>Danish registered design No. 2013 00069 (12.11) (wheeled cargo bike) Owner: 3PART A/S</p> </div> <div style="text-align: center;">  <p>CP6 Example (11.02) (Flower vases)</p> </div> </div> |

3. IMPLEMENTATION

As has been the case previously, this Common Practice took effect within three months of the date of publication of this Common Communication. Further details on the implementation of this Common Practice are available in the table below.

Implementing Offices have the option to publish additional information on their websites.

The following Offices have implemented the common practice: BG, BX, CY, CZ, DE, DK, EE, ES, FR, GR, HR, HU, IE, IS, IT, LT, LV, NO, PL, PT, RO, SI, SK, TR, UK and EUIPO.

The following EU Offices support the common practice, but have not implemented it at this moment in time: AT, FI, MT and SE. At the time of publication, a minority of Offices have legal constraints in specific parts of the Common Practice

which constitute an impediment for its implementation in its entirety, specifically Estonia (sectional views); Czech Republic (sequence of snapshots; Norway (partial views); Croatia (sectional views), and Slovenia (sectional views).

3.1 IMPLEMENTING OFFICES

LIST OF IMPLEMENTING OFFICES, IMPLEMENTATION DATE AND IMPLEMENTATION PRACTICE

| Overview of implementation of the Common Practice | | | |
|---|---------------------|--|---|
| Office | Implementation date | The Common Practice will be applicable to: | |
| | | Applications <u>pending on</u> the implementation date | Applications <u>filed after</u> the implementation date |
| BG | 15.07.2016 | | X |
| BX | 15.04.2016 | X | X |
| CY | 15.07.2016 | | X |
| CZ | 15.07.2016 | | X |
| DE | 15.07.2016 | | X |
| DK | 15.04.2016 | | X |
| EE | 15.07.2016 | | X |
| ES | 15.04.2016 | | X |
| FR | 15.07.2016 | | X |
| GR | 15.04.2016 | X | X |
| HU | 15.07.2016 | | X |
| HR | 15.04.2016 | | X |
| IE | 15.04.2016 | X | X |

| | | | |
|------|------------|---|---|
| IT | 15.07.2016 | | X |
| IS | 15.04.2016 | | X |
| LT | 15.04.2016 | | X |
| LV | 15.07.2016 | | X |
| NO | 15.04.2016 | X | X |
| OHIM | 15.04.2016 | X | X |
| PL | 15.04.2016 | | X |
| PT | 15.07.2016 | X | X |
| RO | 15.07.2016 | | X |
| SI | 15.07.2016 | | X |
| SK | 15.04.2016 | X | X |
| UK | 15.04.2016 | X | X |
| TR | 15.04.2016 | | X |

ANNEX:

PRINCIPLES OF THE COMMON PRACTICE



**Principles of the Common Practice
Convergence Programme**

CP 6. Graphic Representation of Designs

Table of Contents

| | |
|--|-----------|
| 1.OBJECTIVE OF THIS DOCUMENT | 15 |
| 2. THE PROJECT SCOPE..... | 15 |
| 3. THE COMMON PRACTICE | 17 |
| 3.1 Objective 1 - Use of visual disclaimers | 17 |
| 3.1.1 Definitions..... | 18 |
| 3.1.2 General requirements | 18 |
| 3.1.3 General recommendations..... | 19 |
| 3.1.4 Guidelines for the types of visual disclaimers..... | 21 |
| a) Broken lines..... | 21 |
| b) Blurring..... | 23 |
| c) Colour shading..... | 24 |
| d) Boundaries..... | 24 |
| 3.2. Objective 2 - Types of Views..... | 25 |
| 3.2.1 A Definition of view | 26 |
| 3.2.2 Forms/means of representation | 26 |
| 3.2.3 General recommendations for all types of views..... | 27 |
| 3.2.4 Guidelines for each type of view | 28 |
| a) Aspect views | 28 |
| b) Views magnifying part of the design | 29 |
| c) Alternate positions..... | 31 |
| d) Exploded views..... | 33 |
| e) Partial views (fragmentary views)..... | 35 |
| f) Sectional views | 36 |
| g) Sequence of snapshots (animated design)..... | 37 |
| h) Combinations of several means of visual representation | 38 |

| | |
|--|-----------|
| 3.3 Objective 3 - Neutral Background..... | 39 |
| 3.3.1 Requirements related to coloured background | 39 |
| 3.3.2 Requirements related to contrast..... | 42 |
| 3.3.3 Requirements related to shadows/reflections..... | 43 |
| 3.4 Objective 4 - Format of views..... | 45 |
| 3.4.1 Quality recommendations for representations of designs filed in the form of drawings and photographs..... | 45 |
| 3.4.2 Benchmarking study..... | 46 |
| Annex 1: Applications received by paper..... | 47 |
| Annex 2: Applications received electronically..... | 55 |

1. OBJECTIVE OF THIS DOCUMENT

This document will be the reference for EU national and regional IP offices (hereinafter referred to as “the Offices”), User Associations, applicants and representatives on the common practice of the requirements for graphic representation of designs.

These requirements cover the use of visual disclaimers, the use of different types of views and how to reproduce a design on a neutral background. Furthermore, this document also provides recommendations to enhance the applicants’ understanding of how best to reproduce their designs and an overview of the Offices’ quality standards for design applications received by electronic means and by paper.

The following guidance relates to examination procedures only and is not intended to give advice on the scope of protection of a design under National or European law.

2. THE PROJECT SCOPE

The scope of the CP6 project includes:

- **An analysis of the use of visual disclaimers:** This objective aims at harmonising the practice on the use of visual disclaimers as a means to indicate features for which protection is not claimed.
- **An analysis of types of views:** This objective aims at harmonising the practice regarding the types of views that can be accepted by the Offices and the requirements to be established in order to represent correctly designs in an application for registration. This objective also aims at determining if a combination of photographs and drawings is allowed in the representation of a design.
- **An analysis of the requirements for neutral background:** This objective aims at defining the requirements to determine when a background is considered neutral.
- **A benchmarking exercise on format of views:** This exercise aims at creating an overview of the Offices’ quality standards for any design application received by electronic means and by paper. Additionally, the exercise aims at developing recommendations for representations of designs filed in the form of drawings and/or photographs.

The four different objectives are represented in the following figure:

| Convergence Project on Designs (CP6) | |
|--------------------------------------|--|
| Graphic representation of a design | Objective 1: Disclaimers |
| | Objective 2: Types of views |
| | Objective 3: Neutral background |
| | Objective 4: Format of views [limited to general recommendations and a benchmarking exercise] |

Figure 1 - CP6 Scope

The following items are **out of the scope** of the project:

- *Verbal disclaimers.*
- *Additional elements.*
- *Priority (not all the Offices carry out an examination of priority claims).*
- *Disclosure (not all the Offices have invalidity proceedings).*
- *Number of views (a number of Offices have legal constraints).*
- *Computer-animated representations, 3D representations (a number of Offices have legal constraints).*
- *The implementation of the Common Practice itself on behalf of the Offices.*
- *Updating of the Offices' guidelines and manuals. This will follow internal procedures of the implementing Offices.*
- *Legislative changes on behalf of the Offices.*
- *The Common Practice and Common Communication(s) will only explain the Common Practice created and approved by the Working Group. The description of legal constraints preventing*

implementations will not be included. The practices of those Offices that do not adhere to the common practice will not be described.

3. THE COMMON PRACTICE

3.1 Objective 1 - Use of visual disclaimers

A comprehensive analysis of the Offices' practices on visual disclaimers showed that before this project was launched there was no consistent and unified way of using visual disclaimers in an application for registration of a design.

This analysis confirmed that, despite the fact that the majority of Offices accepted visual disclaimers in an application for registration of a design, there were no clear and harmonised rules/requirements to assist applicants to disclose their designs correctly. This resulted in an inconsistent understanding of the purpose of each visual disclaimer by examiners.

To remedy this incongruence in practices within the EU, and due to the importance of appropriate disclosure of the design for the determination of the scope of protection, this chapter on visual disclaimers includes:

- The definition of a design and the definition of visual disclaimers.
- General requirements for the acceptability of visual disclaimers.
- General recommendations provided for all types of visual disclaimers that this document concerns.
- Guidelines for each type of visual disclaimer. These encompass:
 - A definition of each type of visual disclaimer.
 - Requirements for accepting each type of visual disclaimer.
 - Examples.

The proposed structure can be seen in the graphic below:

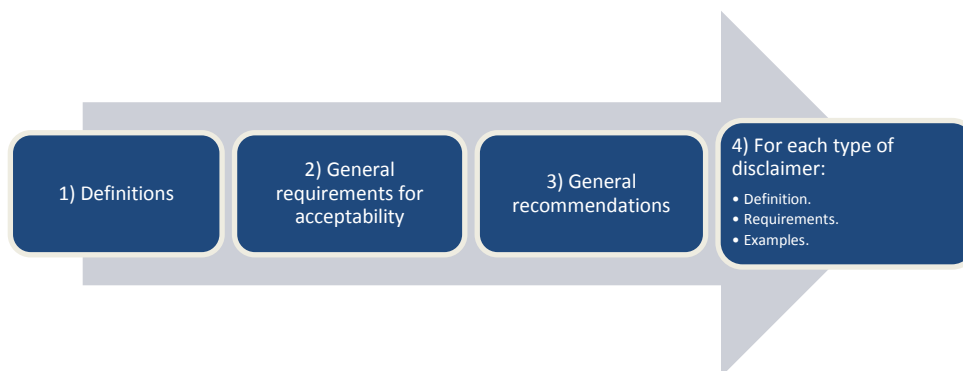

Figure 2 – Visual Disclaimers Chapter Structure

3.1.1 Definitions

a) Definition of a design: a “*design*” means the appearance of the whole or a part of a product resulting from the features of, in particular, the lines, contours, colours, shape, texture and/or materials of the product itself and/or its ornamentation - Article 1 (a) of the Directive 98/71/EC of the European Parliament and of the Council of 13 October 1998 on the legal protection of designs.

b) Definition of visual disclaimers: visual disclaimers indicate that protection is not being sought for, and registration has not been granted for, certain features of the design shown in the representation. Thus, they indicate what is not intended to be protected. This can be achieved:

- By excluding with broken lines, blurring or colour shading the features of the design for which protection is not sought or
- By including within a boundary the features of the design for which protection is sought, thus making it clear that no protection is sought for what falls outside the boundary.

3.1.2 General requirements

The following are the general requirements that need to be fulfilled by all types of visual disclaimers:

a) Visual disclaimers will only be accepted when they clearly indicate that protection is not being sought for certain features of the design shown in the representation.

b) In order to be accepted, when the design is represented in more than one view, the visual disclaimer must be shown consistently in all the views where the disclaimer appears. For example:

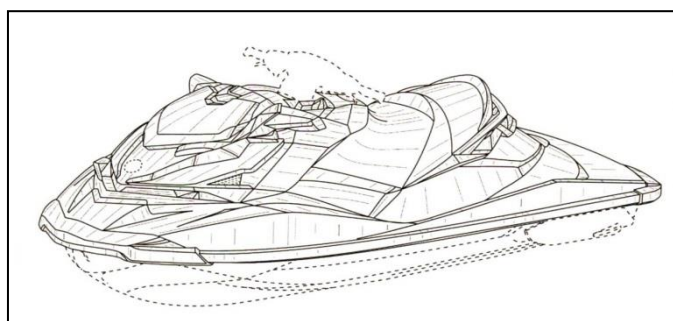
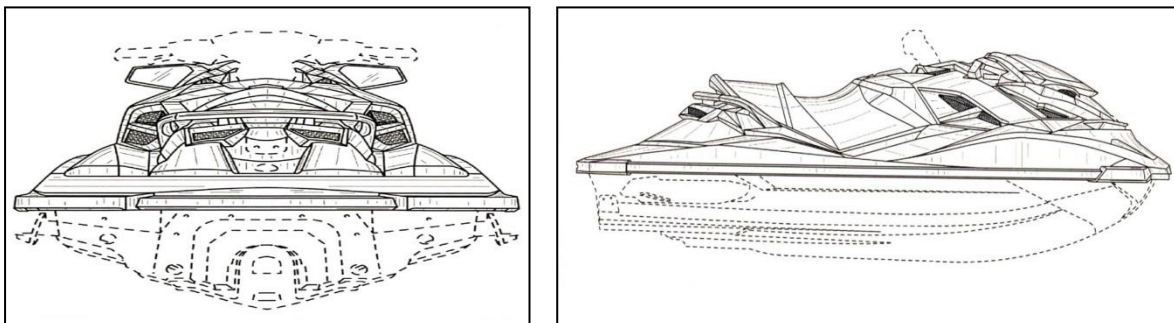

RCD No. 001282545-0001 (12.06) (Water crafts)

Owner: Bombardier Recreational Products Inc.

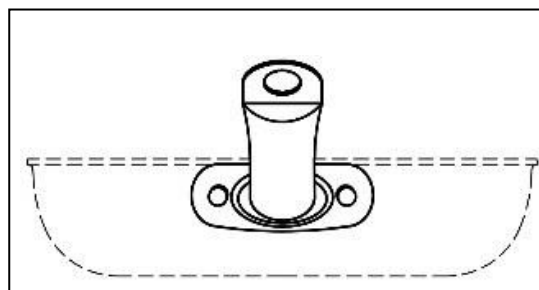
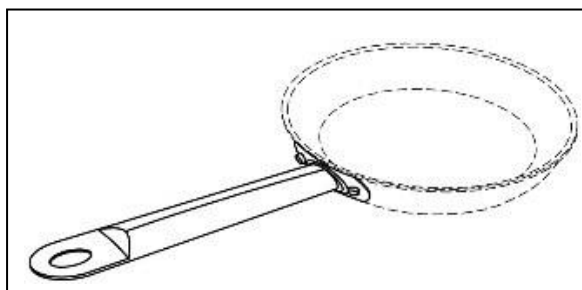

RCD No. 002322644-0001 (07.02) (Pan handles)

Owner: ACTERVIS, GMBH

Example 1 - Consistent use of visual disclaimers

3.1.3 General recommendations

The following general recommendations aim to assist applicants to correctly represent their designs using disclaimers. These recommendations are applicable to all types of disclaimers:

a) Graphic or photographic representations showing only the claimed design are preferred.

b) However, to understand the features of the design for which protection is sought, it may be helpful to show the design in context. In such cases the use of visual disclaimers may be necessary.

c) Correct use:

- The visual disclaimer must be clear and obvious from the representation of the design. There must be a clear distinction between the claimed and the disclaimed features.

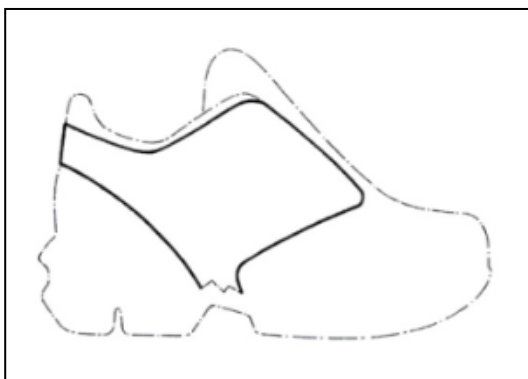

RCD No. 150297-0001 (02.04) (Footwear (part of))
Owner: Salomon SAS



International registration No. DM/078504
(12.08) (Vehicles) Owner: DAIMLER AG

Example 2 - Clear distinction between claimed and disclaimed features

- The visual disclaimer should be self-explanatory when appreciated in the context of the whole design.
- When the representations of the design are line drawings, we recommend the use of broken lines as visual disclaimers.
- However, in cases where broken lines cannot be used due to technical reasons (e.g. when the broken lines are used to indicate stitching for clothes or pattern; or photographs are used), the use of blurring, colour shading, or boundaries is recommended.

d) When to use:

It is recommended that visual disclaimers be used in those cases where the graphic or photographic representation of the design contains parts of the product for which no protection is sought.



RCD No. 002182238-0002 (26.03) (Outdoor lighting)
 Owner: Stanisław Rosa trading as Zakład Produkcji
 Sprzętu Oświetleniowego ROSA

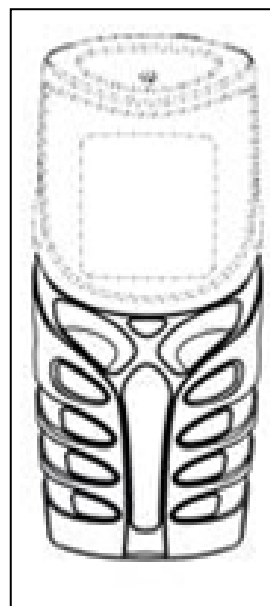

Community design lapsed No. 000030606-0003
 (14.03) (Key button arrangement for mobile)
 Owner: Nokia Corporation

Example 3 - Useful views for showing the context

3.1.4 Guidelines for the types of visual disclaimers

a) Broken lines

Definition: Broken lines consist of a trace made up of dots or dashes (or a combination of both) and are used to indicate that no protection is sought for the features that are shown using an interrupted trace.

A visual disclaimer consisting of broken lines will usually be combined with continuous lines.

Requirements: In order to be accepted, the features for which protection is not sought should be clearly indicated with broken lines, whereas the parts for which protection is sought should be indicated with continuous lines.

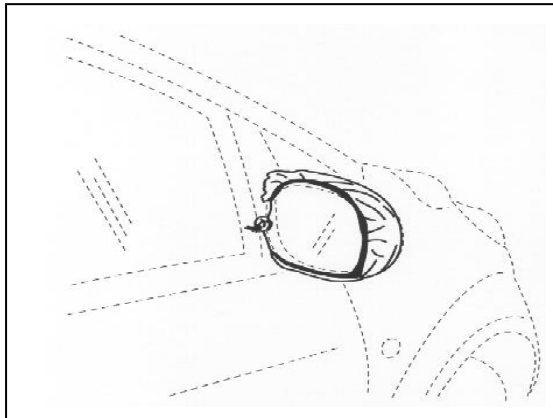

BX registered design No. 38212-0001 (12.16)
(Rearview mirrors) Owner: Interimage BV

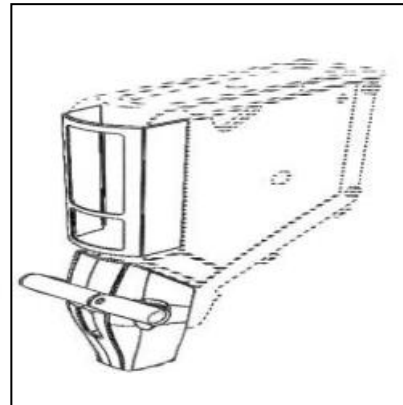

Danish registered design No. 2013 00070 (20.02) (Parts of the
device for storage, display, positioning and distribution of varer)
Owner: Brynild Gruppen AS

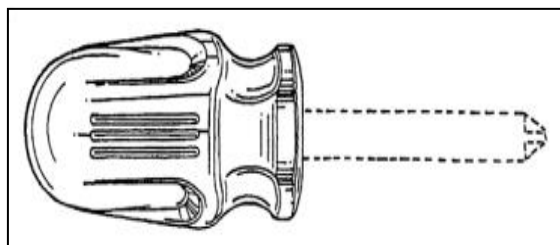

Hungarian registered design No. D9900409-0001 (08.04) (Handle of screwdriver)
Owner: Cooper Industries, Inc.

Example 4 - Broken lines

Note: In cases where broken lines are a feature of the design (such as stitching on clothing), this must be clear from the representation. In such cases, it may be helpful to file, for example, a magnified view.

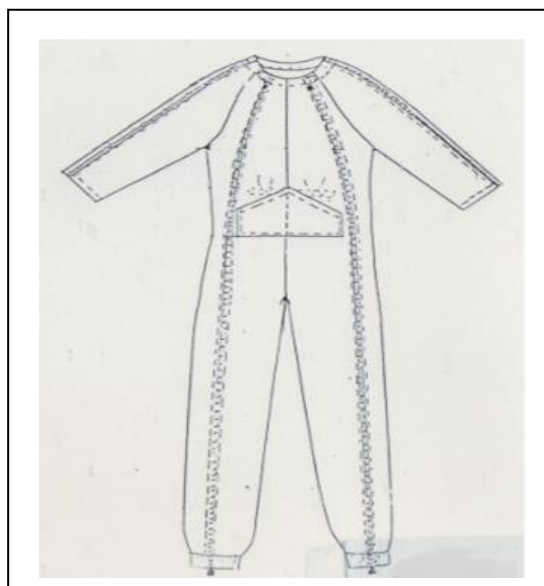

French registered design No.911104-0021 (02.02) (A pocket supporting a urine pouch)
Owner: MULLIEZ FRERES SA SOCIETE INDUSTRIELLE

Example 5 - Broken lines as a feature of the design (such as stitching on clothing)

Note: In cases where broken lines are a feature of the design and a part of the design needs to be disclaimed, this can be done by using any of the other visual disclaimers, such as colour shading, blurring or boundaries.

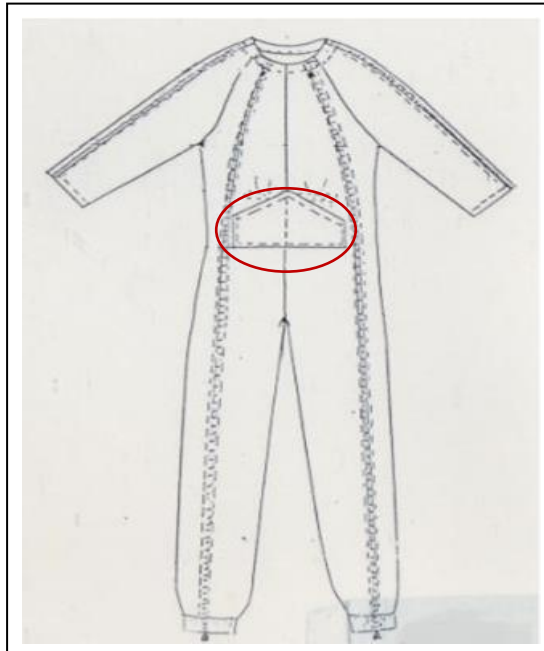

French registered design No.911104-0021 (02.02) (A pocket supporting a urine pouch)

Owner: MULLIEZ FRERES SA SOCIETE INDUSTRIELLE

Example 6 - Use of other disclaimers when broken lines are a feature of the design (such as stitching on clothing)

b) Blurring

Definition: Blurring is a type of visual disclaimer that consists of obscuring the features for which protection is not being sought in drawings or photographs of a design application.

Requirements: Blurring may only be accepted when the features for which protection is sought are clearly distinguishable from the disclaimed (blurred) features.

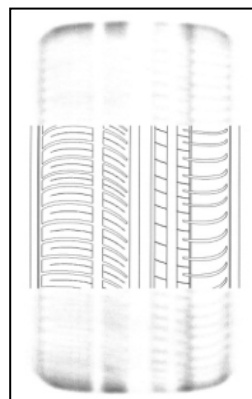

RCD No. 000244520-0002 (12.15) (Tyres for vehicle wheels, pneumatic) Owner: Nokian Tyres plc

Example 7 - Blurring correctly applied

c) Colour shading

Definition: Colour shading is a type of visual disclaimer that consists of using contrasting tones of colour to obscure sufficiently the features for which protection is not being sought in drawings or photographs of a design application.

Requirements: With colour shading, the features for which protection is sought must be clearly shown so that they are neatly perceptible, whereas the disclaimed features must be represented in a different tone of colour and in a way that they appear blurred or imperceptible.



RCD No. 000910146-0004 (12.08) (Automobiles (part of-))
Owner: TOYOTA MOTOR CORPORATION

Example 8 - Colour shading correctly applied

d) Boundaries

Definition: Boundaries are a type of visual disclaimer used in drawings or photographs of a design application to indicate that no protection is sought for the features that are not contained within the boundary.



RCD No. 002182238-0002 (26.03) (Outdoor lighting) Owner: Stanisław
Rosa trading as Zakład Produkcji Sprzętu Oświetleniowego ROSA



RCD No. 001873688-0003 (02.04) (Soles for footwear)
Owner: Mjartan s.r.o.

Example 9 - Boundaries correctly applied

Requirements: In order to be accepted, the features for which protection is sought should be clearly indicated/represented within the boundary, whereas all the features outside the boundary are considered to be disclaimed and therefore not protected.

Recommendation: Boundaries must be carefully used in drawings/photographs due to the risk of including more than just the design within the boundary. For example:



CP6 Example (12.16) (Air-intake grilles for vehicles)



CP6 Example (14.01) (Tone arm to turntables)

Example 10 - Boundaries incorrectly applied

3.2. Objective 2 - Types of views

The applicant should file the types of views considered appropriate for a clear, full and detailed disclosure of the design. If all the features of the design cannot be displayed in one single view, the applicant may submit additional views which are necessary for this purpose, subject to the maximum number of views allowed by each Office.

The following information aims at helping applicants to file a design application correctly with the appropriate type of view while facilitating the work of design examiners. This chapter on types of views contains the following:

- The definition of a view.
- A description of the possible forms/means available to applicants to represent their designs.

- General recommendations provided for all types of views that this document concerns; and
- Guidelines for each type of view. These encompass:
 - A definition of each type of view.
 - Requirements for acceptance of each type of view.
 - Recommendations for filing each type of view (if applicable).
 - Examples.

The proposed structure can be seen in the graphic below:

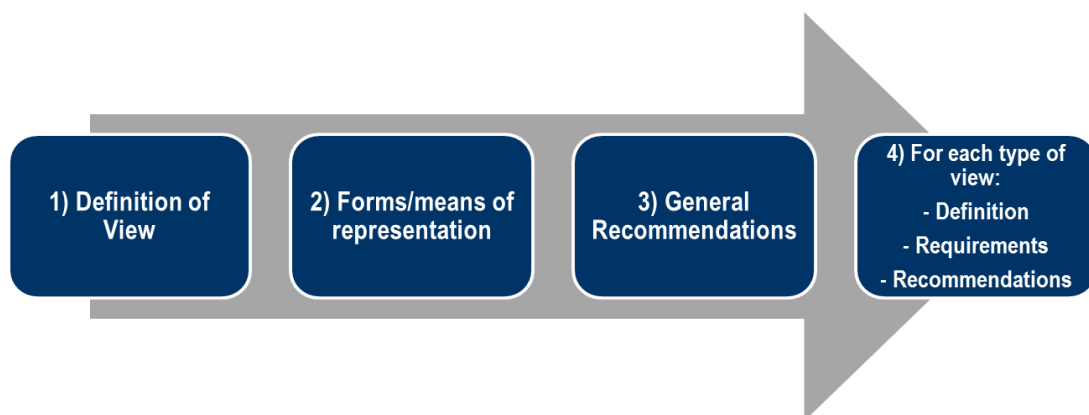

Figure 3 - Types of Views Chapter Structure

3.2.1 Definition of view

A view is a visual representation of the design. It may reproduce the design from various directions (angles) or at different moments in time or in various states.

3.2.2 Forms/means of representation

The representation of the design can be filed in the form of:

- a) Drawings.
- b) Photographs.
- c) Any other means of visual representation admitted by the Offices.

3.2.3 General recommendations for all types of views

The following general recommendations aim to assist applicants to correctly represent their design using types of views. These recommendations are applicable to all types of views:

- a) It is the applicant's responsibility to disclose the features of the design as completely as possible. This is most likely to be achieved by using aspect views of the design. However, the applicant may provide complementary/additional views in order to further disclose the features of the design.
- b) It is not obligatory for the applicant to file a certain number of views or a certain type of view as long as all the features of the design can be clearly perceived by the submitted representation(s), e.g. one view may be sufficient:



RCD No. 002324756-0001 (06.01) (Seating furniture)
Owner: Axmann Investment GmbH



RCD No. 002327015-0001 (12.11) (Bicycle frames)
Owner: Marcin, Kacper Hajek

Example 11 - Sufficient view

- c) The views must belong to one and the same design.
- d) Applicants may file one or more views of the design. Each view must be shown separately.
- e) In case of products consisting of several parts, at least one view must present the whole product.

3.2.4 Guidelines for each type of view

The project deals with the following types of views:

- a) Aspect views.
- b) Views magnifying part of the design.
- c) Alternate positions.
- d) Exploded views.
- e) Partial views.
- f) Sectional views.
- g) Sequence of snapshots.
- h) Combination of several means of visual representations.

a) Aspect views

Definition: Aspect views show the design from certain directions (angles) and encompass the following views: front view, top view, bottom view, right side view, left side view, back view and perspective views.





RCD No. 002325456-0001 (31.00) (Mixers, electric [kitchen])
Owner: KENWOOD LIMITED

Example 12 - Aspect views

Recommendations: It is recommended that the applicant should file as many views as necessary in order to fully disclose the features of the design, subject to the maximum number of views allowed by each Office. In some cases one view can be sufficient.



RCD No. 002319392-0001 (25.04) (Stools steps) Owner: CDH
GROUP (société par actions simplifiée)



RCD No. 002327015-0001 (12.11) (Bicycle frames)
Owner: Marcin, Kacper Hajek

Example 13 - Sufficient view

b) Views magnifying part of the design

Definition: Magnified views show one part of an overall design in an enlarged scale.

Requirements:

- A single magnified view is acceptable provided that the magnified part is already visible in one of the other submitted views.
- The view which shows the magnified part of the design must be presented in a separate single view.

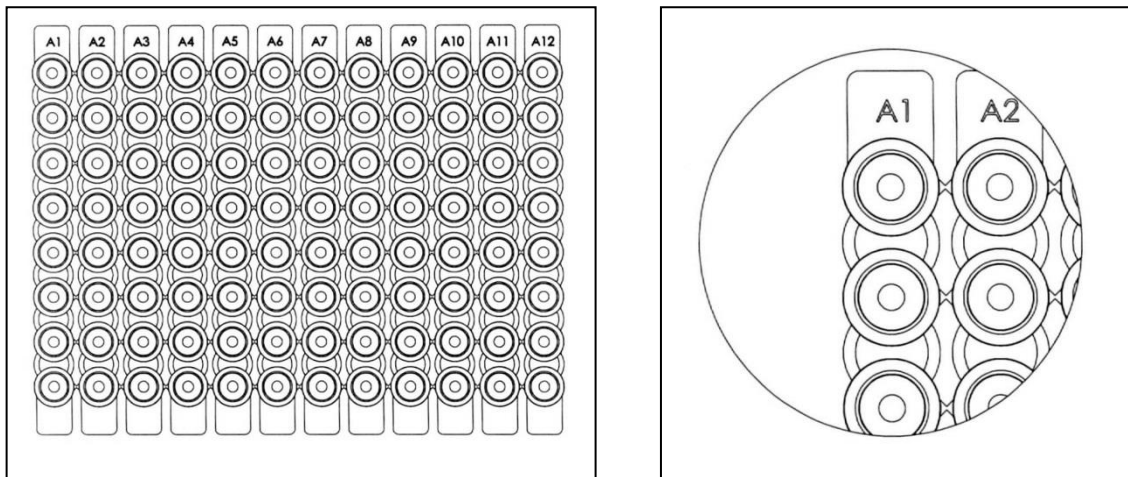

RCD No. 001913690-0002 (24.02) (PCR multi-well plates) Owner: ABGENE LIMITED

Example 14 - Acceptable (different views)

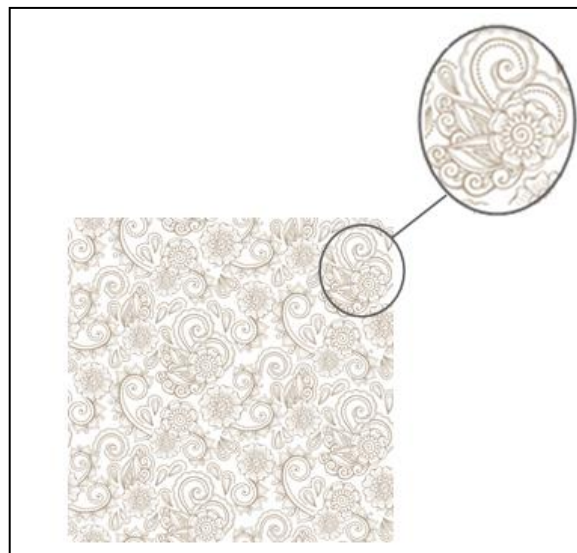

CP6 Example (32.00) (Surface patterns)

Example 15 - Unacceptable (same view)

c) Alternate positions

Definition: Designs with alternate positions have an appearance which can be modified into several configurations without any addition or removal of any parts.

These designs have pre-defined stages of use which each corresponds to an alternate position. In some cases different configurations may result in different products as in the case of a bag which is convertible into a towel (see example 16).

Requirements:

- The views showing the different configurations of the design are acceptable provided no part is added or removed.
- The views showing the different configurations of the design must be shown separately.

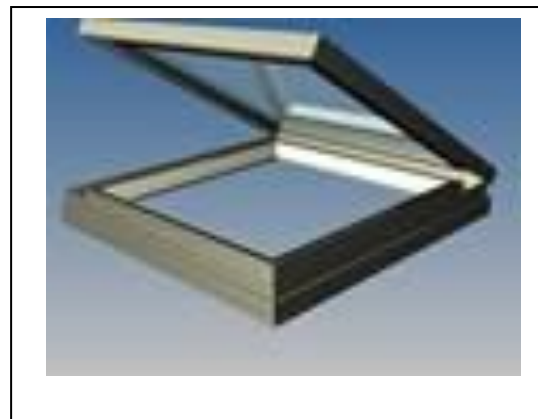
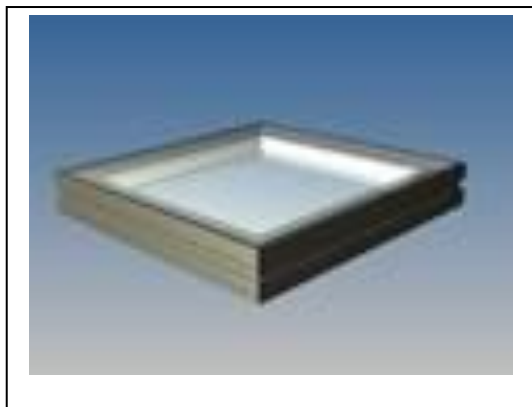

RCD No. 002257493-0001 (25.02) (Roof constructions) Owner: Glazing Vision Ltd.

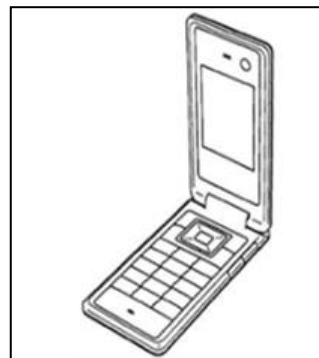

RCD No. 000588694-0012 (14.03) (Mobile phones) Owner: Fujitsu Mobile Communications Limited



RCD No. 002319814-0001 (06.06) (Leisure furniture) Owner: Przedsiębiorstwo Wielobranżowe KAREX Krzysztof Karpiński



RCD No. 002329938-0001 (06.01) (Chairs [seats]) Owner: Stechert Stahlrohrmöbel GmbH



Croatian registered design No. D20110100 (03.01) (Bags with towel and purse) Owner: KO-ART proizvodni, uslužno-servisni i trgovački obrt

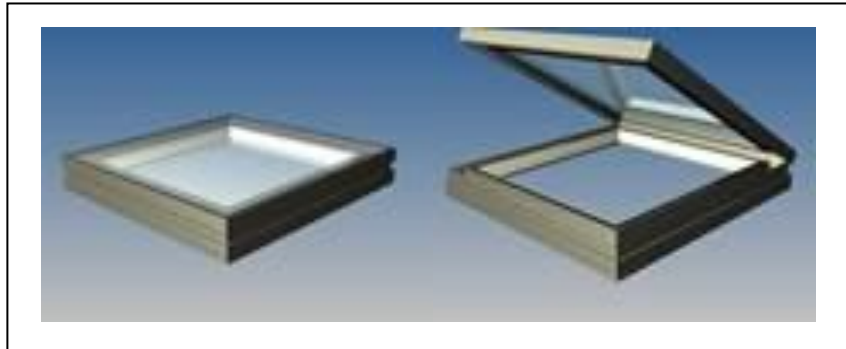

RCD No. 002257493-0001 (25.02) (Roof constructions)
 Owner: Glazing Vision Ltd.

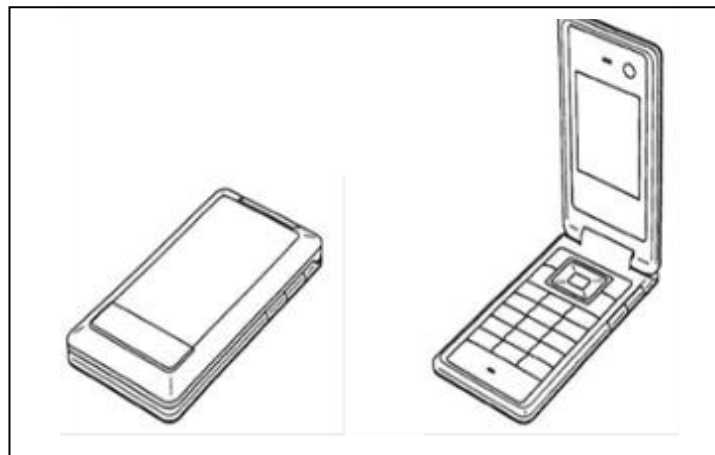

RCD No. 000588694-0012 (14.03) (Mobile
 phones) Owner: Fujitsu Mobile Communications
 Limited

Example 17 - Unacceptable alternate positions (the pre-defined stages of use of the design are shown in the same view)

d) Exploded views

Definition: Exploded views consist of views where the parts of a product are shown disassembled in order to clarify how the parts fit together.

Requirements:

- Exploded views must be combined with at least one view representing the product assembled (see example 18 - view no.2 combined with view no.1).
- In these views, all the parts of a product must be shown disassembled in a separate single view (see example 18 - view no.2).
- The disassembled parts must be shown in close proximity and in order of assembly (see example 18 - view no.2).

View no. 1 Assembled

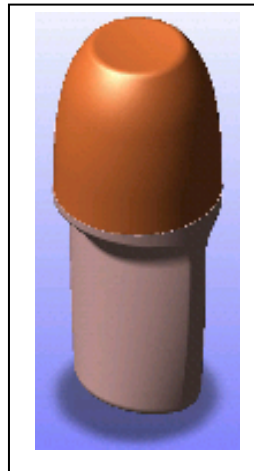

View no. 2 Exploded



RCD No. 001847468-0003 (09.03) (Packaging) Owner: Josefa Colls Llobet

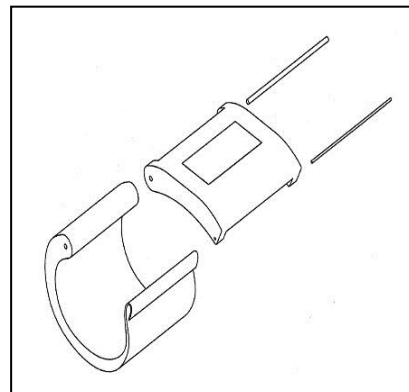
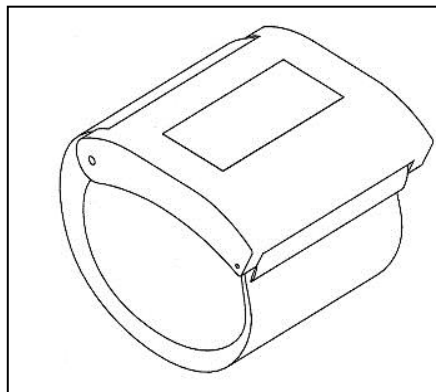

Croatian registered design No. D20140080 (24.01) (Bracelets with muscle stimulator) Owner: Dominik Žinić

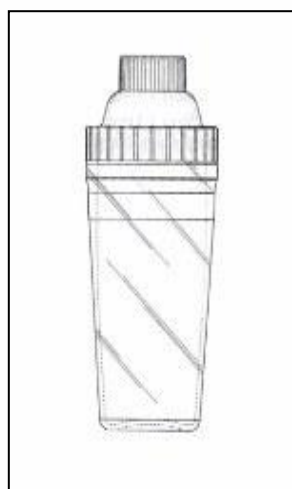

RCD 001385926-0001 (09.03) (Beverage containers) Owner: Mocktail Beverages, Inc.

Note: Showing the exploded parts in an additional view can help to facilitate the understanding of the design. However, the suitability of using exploded views for representing the design is without prejudice to the limitations foreseen by the National or European law in respect of the protection of invisible or partially visible parts of a product when in use.

e) Partial views (fragmentary views)

Definition: A partial view is a view showing a part of a product in isolation. A partial view can be magnified.

Requirements:

- Partial views must be combined with at least one view representing the product assembled (the different parts need to be connected to each other) - see example 19, views no.2, 3 and 4 combined with view no.1.

Assembled view no. 1



Partial view no. 2



Partial view no.3



Partial view no. 4



RCD No. 2038216-0001 (15.01, 23.04) (Air filters, Containers for air filters, for engines)

Owner: BMC S.r.l.

Example 19 - Partial views

- Those Offices which accept a set of articles as being one single product are free to apply the same requirements.

f) Sectional views

Definition: Sectional views are cutaway portions that complement aspect views by illustrating a feature or features of the appearance of the product such as the contour, surface, shape or configuration of the product.

Requirements:

- Representations with technical indications, such as axial lines or sizes (dimensions), numbers, etc. are not acceptable.
- The sectional view should, in an unambiguous way, be a view of the same design.
- Sectional views should not be submitted without other traditional views such as aspect views.

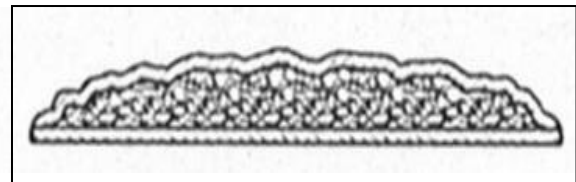
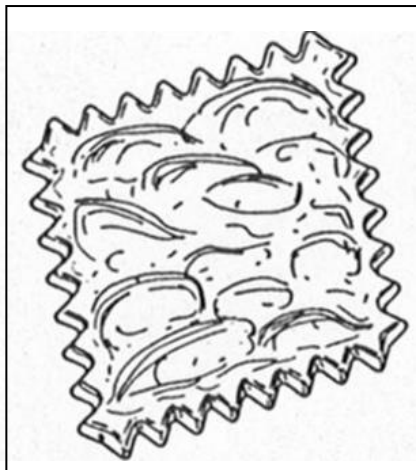

Spanish registered design No. I0152702-D (01.01) (Biscuits) Owner: CUETARA, S.L.

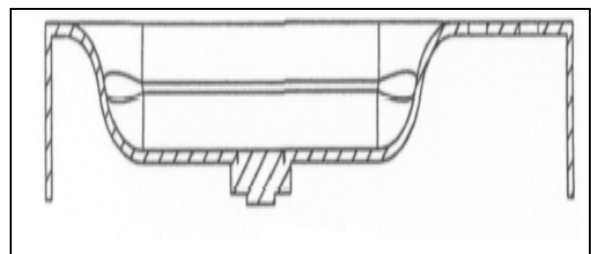
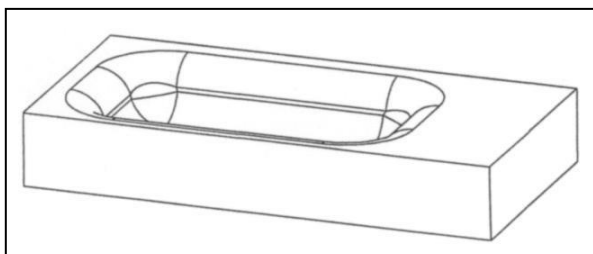

BX registered design No. 38478-0002 (23.02) (Washbasins) Owner: Maan Amsterdam Holding BV

Example 20 - Sectional views

Note: Adding sectional views can help to facilitate the understanding of the design. However, the suitability of using such views for representing the design is without prejudice to the limitations foreseen by the National or European law in respect of the protection of invisible or partially visible parts of a product when in use.

g) Sequence of snapshots (animated design)

Definition: Snapshots are a short sequence of views used to show a single animated design at different specific moments in time, in a clearly understandable progression. This applies to:

- An animated icon (design consisting of a sequence)

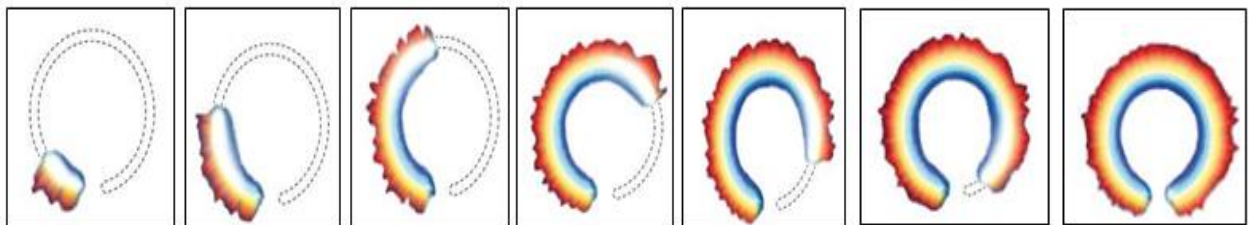

RCD No 2085894-0014 (14.04) (Animated screen displays) Owner: NIKE Innovate C.V.

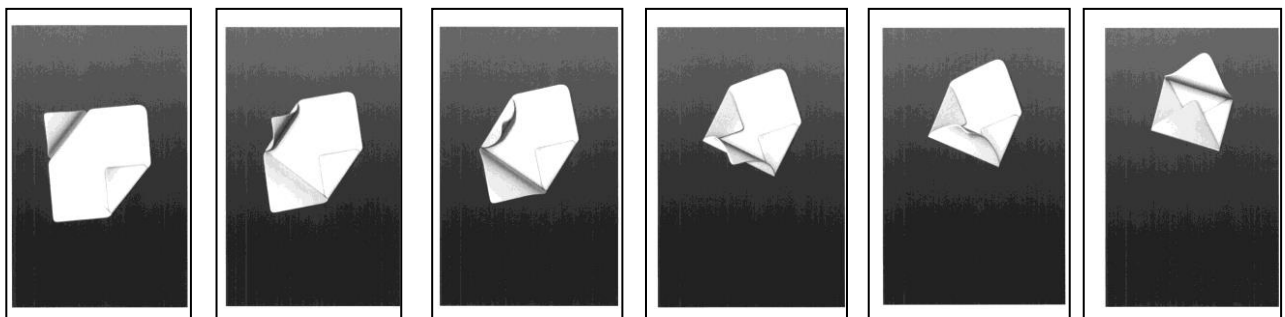

RCD No 001068001-0002 (14.04) (Icons, Animated icons, Screen displays and icons) Owner: Deutsche Telekom AG

Example 21 - Acceptable animated icons

- An animated graphical user interface (design of an interface).

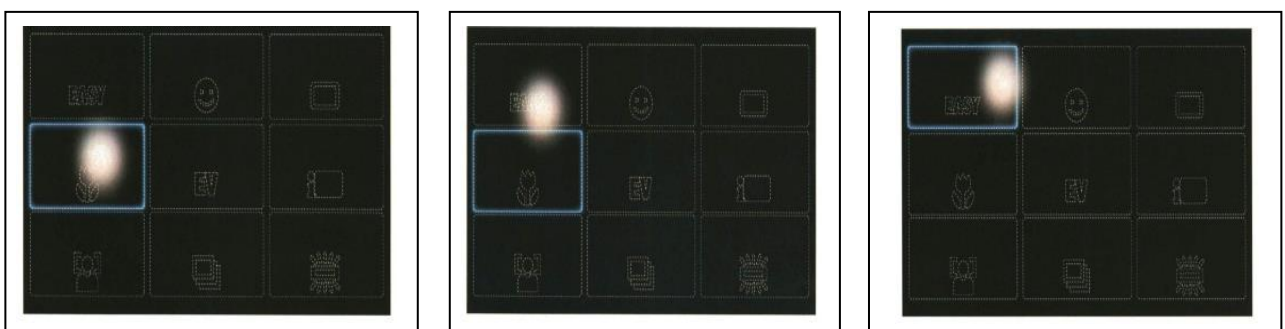

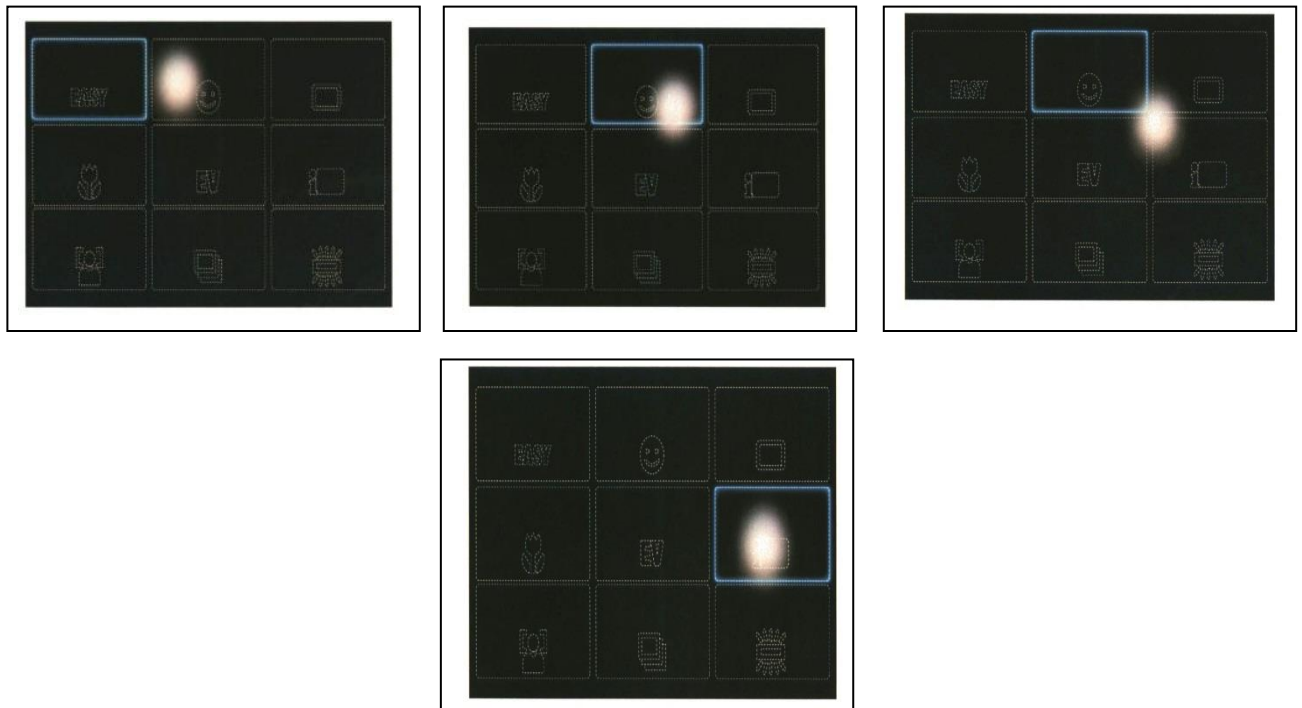

RCD No 001282388-0031 (14.04) (Animated graphical user interfaces for a display screen or portion thereof) Owner: Sony Corporation

Example 22 - Animated graphical user interface

Requirements:

- In principle, all views of an animated icon and graphical user interface need to be visually related, this means that they must have features in common.
- It is the responsibility of the applicant to number the views in such a way so as to give a clear perception of the movement/progression.

Note: A video clip is a potential way of representing such designs (as it allows the sequence of the movement to be seen and visually appreciated), although the technical means to file a design by submitting a video clip are not available yet.

h) Combination of several means of visual representation

Recommendation:

A design should be represented using only one visual format (drawing or photograph) so as to avoid disclosing aspects that contribute to a different overall impression. Where multiple representations of a design are used, each must clearly and obviously relate to the same design and be consistent when comparing the features disclosed.

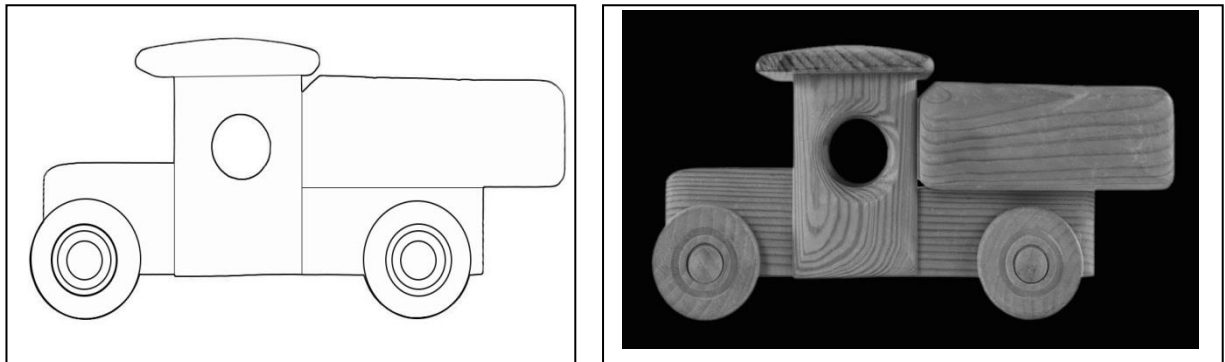

CP6 Example (21.01) (Vehicles [toys])

Example 23 - Unacceptable combination**3.3 Objective 3 - Neutral background**

An extensive analysis of the Offices' practices on neutral background determined that, although the Offices required design applications to be reproduced on a neutral background, there was no common approach among them when it comes to interpreting the notion of neutral background. This situation prevented the establishment of clear and harmonised requirements meant to assist applicants on how to represent their designs correctly on a neutral background throughout the EU.

Therefore, in order to assess if a background is neutral, the following aspects should be taken into consideration: colours, contrast and shadows.

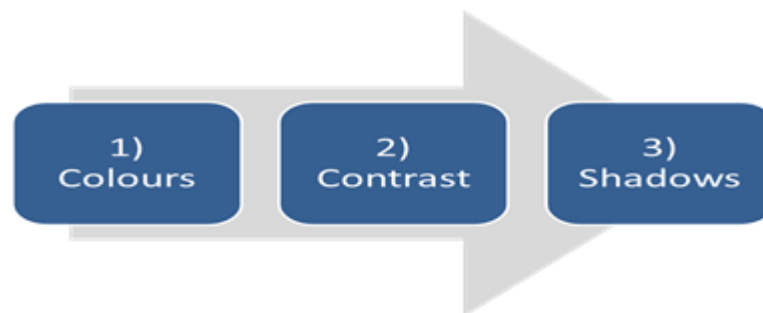

Figure 4 - Neutral Background chapter structure

3.3.1 Requirements related to coloured background

- a) A single or predominant colour in a background is always acceptable if it stands out against the colours of the design.



Austrian lapsed design No. 1747/1999 (01.01) (Ice lolly)
Owner: Schöller Lebensmittel GMBH & O. KG

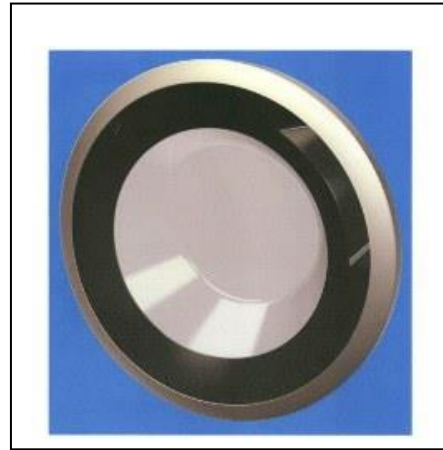

RCD No. 001390298-0001 (15.05) (Washing machines
[part of-]) Owner: BSH Hausgeräte GmbH

Example 24 - Acceptable single coloured background



CP6 Example (09.02) (Jerricans)

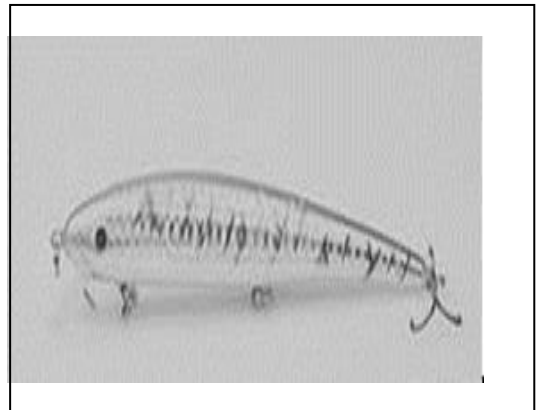

CP6 Example (22.05) (Bait for fishing)

Example 25 - Unacceptable single coloured background



RCD No. 002333484-0001
(02.02) (Sportswear) Owner: La Hoya Lorca - Club de fútbol

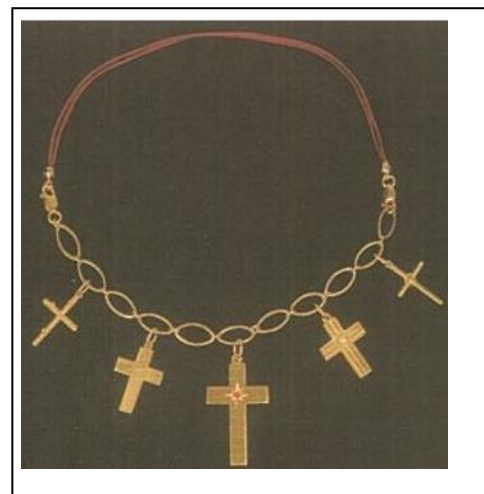

Greek lapsed design No. 20040600136-0001 (11.01)
(Bracelet) Owner: Maria Mantzagrioti Meimaridi

Example 26 - Acceptable predominant coloured background



CP6 Example (01.01) (Cakes)

Example 27 - Unacceptable predominant coloured background

- b) Graduating colour and more than one colour in a background is acceptable if the design is clearly distinguishable.



Danish registered design No. 2013 00008
(23.01) (Taps) Owner: Line Nymann, Emilie
Kampmann, Nadja Ibsen, Pernille Hinborg



RCD No. 001387476-0001 (09.01) (Bottles)
Owner: Vandemoortele Lipids, naamloze vennootschap

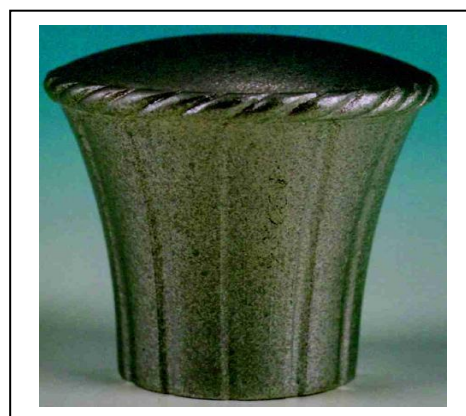

French registered design No. 955805-0005 (09.07)
(Cover for perfume bottle) Owner: SNIC SARL

Example 28 - Acceptable graduating/more than one coloured background

3.3.2 Requirements related to contrast

- a) All features of the design should be clearly visible.
- b) The contrast is considered insufficient when the colour of the background and the design are similar and partly melt into each other. The result is that not all parts of the design will have sufficient contrast with the background (i.e. it is not clear where the product finishes and the background starts).
- c) Sometimes a darker background can help when the design is clear or pale and vice-versa.



BX registered design No. 38895-00 (25.03)
(Shed) Owner: Herman Lankwarden

Example 29 - Sufficient contrast

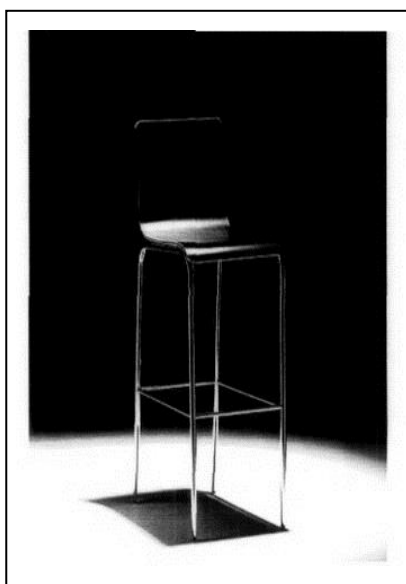

Portuguese lapsed design No. 420-0006
(06.01) (Chairs) Owner: Abril Mobiliário



CP6 Example (06.01) (Chairs)



RCD lapsed design No. 000234265-0001 (09.01)
(Bottles) Owner: Torgovy Dom Aroma (ZAO)

Example 30 - Insufficient contrast

3.3.3 Requirements related to shadows/reflections

- a) Shadows or reflections are acceptable as long as all features of the design remain visible.
- b) Shadows or reflections are unacceptable when the subject of protection of the design, in any of the submitted views, cannot be determined in an unambiguous way.

This can occur when:

- there is limited colour contrast with the design;
- shadows do not allow the appreciation of all the features of the design, for example because they interfere with, or hide parts of, the design or they distort the contour of the design.



Danish registered design No. 2013 00030 (08.05, 08.08) (Holder) Owner:KITCINO ApS

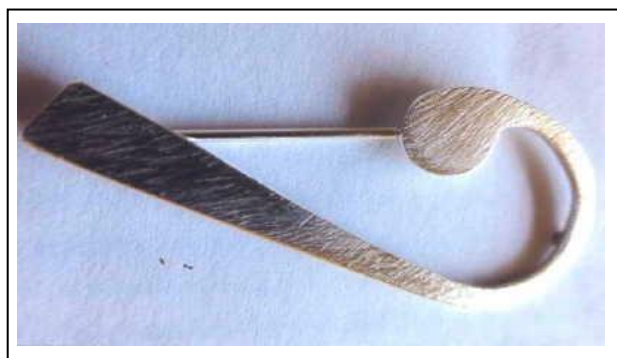

Danish registered design No. 2013 00057 (11.01) (Jewellery) Owner: House of Hearing



Danish registered design No. 2013 00069 (12.11) (Wheeled cargo bike) Owner: 3PART A/S

Example 31 - Acceptable shadows



CP6 Example (11.02) (Flower vases)



CP6 Example (14.01) (Headphones)

Example 32 - Unacceptable shadows



CP6 Example (11.01) (Finger rings)

Example 33 - Acceptable reflections



CP6 Example (07.01) (Fruit bowls)



CP6 Example (07.01) (Fruit bowls)

Example 34 - Unacceptable reflections

3.4 Objective 4 – Format of views

A thorough analysis of the legal provisions of the Offices determined that some have legal constraints regarding the quality standards required for applications received by electronic means and by paper. Since it is not possible to reach a common practice on this topic due to the existence of legal constraints, a benchmark study was carried out and the results of which are provided at the end of this document (Annexes 1 and 2). Furthermore, in order to enhance the users' understanding on how best to reproduce their designs, recommendations for representations of the designs filed in the form of drawings and/or photographs are provided below.

3.4.1 Quality recommendations for representations of designs filed in the form of drawings and/or photographs

a) In the form of drawings: The drawings should be of good quality so that the images are drawn with clear and dark continuous lines. Representations should be capable of being reproduced so that the features of the design remain clearly visible.

Thus, the following should be avoided in the representations:

- Poor line quality.
- Blurry lines.
- Substantial pixilation.
- Lines which merge forming black and undefined areas.
- Drawings which are excessively small or large.
- Drawings with signs of deletion or correction.

b) In the form of photographs: The representations of the design filed in the form of photographs must be of good quality. The design must be shown in such a way that all features of the displayed design are clearly visible and suitable for reproduction. In order to guarantee the quality of the photographs representations, the following should be avoided:

- Undefined areas due to a lack of lighting.
- Glare on shiny, reflective or transparent surfaces.
- Blurriness (unless used as a disclaimer).
- Poor contrast.
- Obvious deletions or corrections.

3.4.2 Benchmarking study on:

a) Paper Design Application (Annex 1)

- Representation of the design on paper (e.g. size of the separate sheet and other requirements).
- Maximum number of designs per application and maximum number of views per design;
- Number of representations submitted per sheet.
- Number of representations per view.
- Indication of number of views.
- Acceptance of descriptions within the representation e.g. front view, back view.
- Acceptance of technical drawings, explanatory text, wording or symbols within the representation.
- Number of copies required.
- Dimensions in cm of the representation of photographs and drawings in single and multiple applications (minimum and maximum).

b) Electronic Design Application (Annex 2)

- Maximum number of views per attachment.
- Maximum number of designs uploaded per application and maximum number of views uploaded per design.
- File format type.
- Total application size limit.
- Size limit per view.
- Minimum and maximum resolution (dpi).
- Offices with an e-filing system.

ANNEX 1: Applications received by paper

| | Representation of the design on paper (e.g. size of the separate sheet and other requirements) | Maximum number of designs per application | Maximum number of views submitted per design | Number of representations that can be submitted per sheet | Each representation corresponds to one view? | Dimensions of the representation on photographs and drawings in a single and multiple application (minimum and maximum) | Is the number of views indicated? | Are descriptions of the types of views allowed e.g. front view, back view? | Are technical drawings; explanatory text, wording or symbols allowed within the representation? | Number of Copies required |
|----|--|---|--|---|--|---|-----------------------------------|--|---|--|
| BG | A4 (29.7 cm x 21 cm) | No Limit | Max 7 Views | 6 | Yes | Min 3 cm x 4 cm and 14 cm x 24 cm | Yes | Yes | No | Two copies of each representation |
| BX | A4 | 50 | No Limit | 24 repr. | Yes | Min 4 cm x 4 cm and Max 16 cm x 24 cm | No | Yes | No | Three copies of each representation including one copy on paper application. |
| CH | A4 | No Limit | No Limit | Several views are possible | Yes | Max: A4 | Yes | Yes, but beside the picture | No | Only one copy |
| CY | A4 (29.7 cm x 21 cm) | 50 | No Limit | | Yes | Max: 6 cm x 6 cm | Yes | Yes | Yes | Only one copy |
| CZ | No Limit, recommendation A4 | No Limit | No Limit | No Limit | Yes | No Limit | Yes | Yes, on the separate sheet | No | Five copies of each representation |

| | Representation of the design on paper (e.g. size of the separate sheet and other requirements) | Maximum number of designs per application | Maximum number of views submitted per design | Number of representations that can be submitted per sheet | Each representation corresponds to one view? | Dimensions of the representation on photographs and drawings in a single and multiple application (minimum and maximum) | Is the number of views indicated? | Are descriptions of the types of views allowed e.g. front view, back view? | Are technical drawings; explanatory text, wording or symbols allowed within the representation? | Number of Copies required |
|----|--|---|--|--|---|---|-----------------------------------|--|---|--|
| DE | The design shall be reproduced on the official forms (A4) | 100 | Max. 10 views | No limit. However, for every design in a multiple application a separate form is to use. | Following § 7 III 3 Design (Design Implementing Regulation) one repr. shall only show one view of the design (not 2 objects of the same design within one view) - but not a view in a standardised. | Min:3 cm x 3 cm | Yes, they are to be indicated. | No. This is to explain in a separate description. | No | One set is enough. No copies are required. |
| DK | No Limit | No Limit | No Limit | No Limit | Yes | No Limit | Yes | No | No | Only one copy |
| EE | A4 (29.7 cm x 21 cm) | No Limit | No Limit | No Limit | Yes | No Limit | Yes | No | No | Two copies of each representation |
| ES | A4 | 50 | Max. 7 views | 7 | Yes | 26.2 cm x 17cm | Yes | No | Upper part | Only one copy |
| FI | A4 | No Limit | No Limit | No Limit | Yes | No min. limitations but should be visible max. A4 | Yes | No | No | Two copies included |

| | Representation of the design on paper (e.g. size of the separate sheet and other requirements) | Maximum number of designs per application | Maximum number of views submitted per design | Number of representations that can be submitted per sheet | Each representation corresponds to one view? | Dimensions of the representation on photographs and drawings in a single and multiple application (minimum and maximum) | Is the number of views indicated? | Are descriptions of the types of views allowed e.g. front view, back view? | Are technical drawings; explanatory text, wording or symbols allowed within the representation? | Number of Copies required |
|----|--|---|---|---|--|---|-----------------------------------|--|--|---|
| FR | A4 (29.7 cm x 21 cm) | 100 | No Limit | 1 | Yes | Min:8 cm in at least one of the dimensions Max:15 cm by 18 cm | Yes | No | Only for Class 1908 | Two copies of each representation |
| GR | A4 | 50 | No limitation to the number of views per design | N/a | Yes | Max:16 cm x 16 cm | Yes | No | No text is allowed.No graphical symbols in representations. Technical drawings are accepted as long as they don't contain text. | No photocopies accepted, no photos from polaroid films accepted, images should be suitable for offset publication |

| | Representation of the design on paper (e.g. size of the separate sheet and other requirements) | Maximum number of designs per application | Maximum number of views submitted per design | Number of representations that can be submitted per sheet | Each representation corresponds to one view? | Dimensions of the representation on photographs and drawings in a single and multiple application (minimum and maximum) | Is the number of views indicated? | Are descriptions of the types of views allowed e.g. front view, back view? | Are technical drawings; explanatory text, wording or symbols allowed within the representation? | Number of Copies required |
|----|---|---|--|--|--|---|-----------------------------------|--|---|---------------------------|
| HR | A4 (29.7 cm x 21 cm); The design shall be reproduced on white paper and either pasted or printed directly on it. Graphic or photographic representations of a design shall have right angles and straight edges, may not be folded, marked or connected with the form by perforations. | No Limit | Max 6 Views | 1 | Yes | Min: 4 cm x 4 cm; Max: 26.2 cm x 17 cm; a margin of at least 2.5 cm shall be left on the left-hand side | Yes | No | No | Only one copy |
| HU | A4 | 50 | No Limit | No number limits but there are minimum and maximum sizes requirements (see Dimensions of the representation). If a sheet contains more than 1 representation, there should be a clear space between each representation (minimum 2 cm). | The representation should present the design in an unambiguous way | Photos:Min:3 cm x 4 cm Max:12 cm x 15 cm Graphical representation:Max:A4 Space on the top of each paper sheet (2.5 cm) | Yes | No - The representation is not allowed to have any added lines what could disturb the understanding of the design such as broken lines, cross hatched lines or any explanation comments or titles. See HIPO legal prov: Decree No. 19/2001 on the detailed formal requirements. | No - See HIPO legal provisions: Decree No. 19/2001 on the detailed formal requirements. | One copy |

| | Representation of the design on paper (e.g. size of the separate sheet and other requirements) | Maximum number of designs per application | Maximum number of views submitted per design | Number of representations that can be submitted per sheet | Each representation corresponds to one view? | Dimensions of the representation on photographs and drawings in a single and multiple application (minimum and maximum) | Is the number of views indicated? | Are descriptions of the types of views allowed e.g. front view, back view? | Are technical drawings; explanatory text, wording or symbols allowed within the representation? | Number of Copies required |
|----|--|---|--|---|--|---|-----------------------------------|---|---|--|
| IE | A4 | 100 | No Limit | 1 | Yes | Min 9 cm x 12 cm Max 18 cm x 24 cm | Yes | Yes | No | One |
| IS | A4 (21 cm x 29.7 cm) | No Limit | No Limit | No Limit | Yes | No minimum, maximum 21 cm x 29.7 cm | Yes | For explanatory purposes illustrations may be given descriptive labels (e.g. "up", "down", "cross-section") | No | Two copies of each illustration of a design shall be submitted |
| IT | A4 | No Limit | No Limit | 1 | Yes | A4 size (29.7 x 21 cm) | Yes | Yes | No | Only one copy |

| | Representation of the design on paper (e.g. size of the separate sheet and other requirements) | Maximum number of designs per application | Maximum number of views submitted per design | Number of representations that can be submitted per sheet | Each representation corresponds to one view? | Dimensions of the representation on photographs and drawings in a single and multiple application (minimum and maximum) | Is the number of views indicated? | Are descriptions of the types of views allowed e.g. front view, back view? | Are technical drawings; explanatory text, wording or symbols allowed within the representation? | Number of Copies required |
|----|--|---|--|--|--|---|-----------------------------------|--|---|--|
| LT | A4 | 100 | No Limit | 1 | Yes | Max:200 mm x 150 mm (= 20 cm x 15 cm) | Yes | No | No | Three copies of each view of the design. |
| LV | A4 | No Limit | No Limit | In case of several representations there should be 2 cm empty spaces between each representation | Yes | Min:9 cm x 12 cm Max:A4 format | Yes | No | No | Two copies of each illustration of a design shall be submitted |
| MT | A4 | 1 | 7 | 1 | Yes | Min. 6 cm x 6 cm Max. 16 cm x 18 cm | Yes | Yes | No | One copy |
| NO | A4 | No Limit | No Limit | No Limit | Yes | The dimension of the representations must be at least 3 cm Min: 5 mm wide | Yes | No | No | Only one copy |

| | Representation of the design on paper (e.g. size of the separate sheet and other requirements) | Maximum number of designs per application | Maximum number of views submitted per design | Number of representations that can be submitted per sheet | Each representation corresponds to one view? | Dimensions of the representation on photographs and drawings in a single and multiple application (minimum and maximum) | Is the number of views indicated? | Are descriptions of the types of views allowed e.g. front view, back view? | Are technical drawings; explanatory text, wording or symbols allowed within the representation? | Number of Copies required |
|----|---|---|--|---|--|--|-----------------------------------|--|---|--|
| PL | A4 | 10 | No Limit | No Limit | Yes | Min.: 5 cm x 5 cm. Max 13 cm x18 cm | Yes | No | No | One copy |
| PT | A4. (The design shall be reproduced on opaque white paper (A4) and either pasted or printed directly on it. The sheets of paper shall not be folded or stapled) | 100 | Max 7 views | Preference one for sheet | Yes | Photographs: the dimension of the representations must be at least 10 cm x 15 cm; Drawings: a margin of at least 2.5 cm shall be left on the left-hand side, 1.5 cm on right- hand side, 2.5 cm on the top and 1 cm at the bottom | Yes | NO - we accept the description separately | No | Only one copy |
| RO | A4 | 100 | No Limit | Min 1, max 12 | Yes | Min: 60 mm x 60 mm or a multiple thereof (min 6 cm x 6 cm) Max:180 mm x 240 mm (18 cm x 24 cm) | Yes | For the moment, no but could be acceptable | No | Three copies of each representation including one copy on paper application. |

| | Representation of the design on paper (e.g. size of the separate sheet and other requirements) | Maximum number of designs per application | Maximum number of views submitted per design | Number of representations that can be submitted per sheet | Each representation corresponds to one view? | Dimensions of the representation on photographs and drawings in a single and multiple application (minimum and maximum) | Is the number of views indicated? | Are descriptions of the types of views allowed e.g. front view, back view? | Are technical drawings; explanatory text, wording or symbols allowed within the representation? | Number of Copies required |
|----|--|---|--|---|--|---|-----------------------------------|---|---|---------------------------|
| SE | A4 | No Limit | No Limit | No Limit | Yes | Max: A4 | Yes | Yes, for explanatory purpose | No | Only one copy |
| SI | Indefinite | No Limit | Max 6 views | No Limit | Yes | Min: 3 cm x 3 cm Max: 16 cm x 16 cm | Yes | No | No | 3 Copies of each repr. |
| SK | Min: A6 Max: A4 | No Limit | No Limit | Not determined | Yes | Min: A6 Max: A4 | Yes | No | No | Three copies |
| TR | A4 | No Limit | No Limit | Max. 4 | Yes | Min: 8 cm x 8 cm Max: 16 cm x 16 cm | Yes | No | No | Only one copy |
| UK | A4 | | Max. 7 views | 1 | | | No | Yes. The figures showing the design should be illustrated in an upright position with each figure designated appropriately (for example, perspective view, front view, side view and so on) | No. Only for cross-sectional views. Measurements or any other technical specifications should not be included in the representations. | Only one copy |

| | Representation of the design on paper (e.g. size of the separate sheet and other requirements) | Maximum number of designs per application | Maximum number of views submitted per design | Number of representations that can be submitted per sheet | Each representation corresponds to one view? | Dimensions of the representation on photographs and drawings in a single and multiple application (minimum and maximum) | Is the number of views indicated? | Are descriptions of the types of views allowed e.g. front view, back view? | Are technical drawings; explanatory text, wording or symbols allowed within the representation? | Number of Copies required |
|-------|---|---|---|---|--|---|-----------------------------------|--|---|---------------------------|
| WIPO | A4 | 100 | No limit | Several views are possible | Yes | Min 3 cm x 3cm Max 16 cm x 16 cm | Yes | No, we accept legends separately | No. Measurements or any other technical specifications should not be included in the representations. | Only one copy |
| EUIPO | Design reproduced on opaque white paper either pasted or printed directly on it. The sheets of paper shall not be folded or stapled | No Limit | No limit However, a maximum of 7 views will be registered/ published | 1 | Yes | Max 26.2 cm x 17 cm A margin of at least 2.5 cm shall be left on the left-hand side | Yes | Yes | No | Only one copy |

ANNEX 2: Applications received electronically

| | Maximum number of views per Attachment | Maximum number of designs uploaded per application | Maximum number of views uploaded per design | File Format Type | Total Application Size Limit | Size Limit per View | Minimum and Maximum resolution (dpi) | Does your office have an E-Filing system? If so, which one? If not, is it foreseen? |
|----|--|--|---|----------------------------------|------------------------------|---------------------|--------------------------------------|---|
| BG | One view per attachment | No limit | 7 | JPG, PNG, GIF | Max 50 MB | 1 MB | No Limit | https://portal.bpo.bg . |
| BX | One view per attachment | 50 | No limit | JPEG/GIF | No maximum, no check | 2 MB | No Limit | E-Filing system from Cooperation Fund and adapted for the BOIP |
| CH | Several views are possible | No limit | No limit | All formats which can be handled | Max. 20 MB | 20 MB | Ideally 300 dpi | No, but you can send your application by e-mail. |
| CY | Electronic filing is not available - TBD | | | | | | | |
| CZ | No Limit | No limit | No limit | No Limit | No Limit | No Limit | No Limit | Yes |
| DE | One view per attachment | | | JPG | | 2 MB | Min 300 dpi | |

| | Maximum number of views per Attachment | Maximum number of designs uploaded per application | Maximum number of views uploaded per design | File Format Type | Total Application Size Limit | Size Limit per View | Minimum and Maximum resolution (dpi) | Does your office have an E-Filing system? If so, which one? If not, is it foreseen? |
|----|--|--|---|------------------|----------------------------------|---------------------|--------------------------------------|---|
| DK | No limit | No limit | No limit | PDF | No limit, but max 10 MB per file | 10 MB | No limit | We have an E-filing system, developed in-house by DKTPO |
| EE | One view per attachment | No limit | No limit | JPG, GIF, BMP | No limit | No limit | No limit | Yes. CFO is intended for future use. |
| ES | One view per attachment | 50 | 7 | JPG | MAX 50 MB | 2 MB | | E-FILING from the EUIPO |
| FR | One view per attachment | 100 | 100 | JPG/GIF/PNG | None | 5MB | Min 300 dpi | Yes in-house e-filing system |
| FI | Electronic filing is not available | | | | | | | |
| GR | One view per attachment | Max 50 designs per application | Max 20 views per design | JPG | | 2 MB | | EUIPO's DS e-filing adopted to the Greek Law |

| | Maximum number of views per Attachment | Maximum number of designs uploaded per application | Maximum number of views uploaded per design | File Format Type | Total Application Size Limit | Size Limit per View | Minimum and Maximum resolution (dpi) | Does your office have an E-Filing system? If so, which one? If not, is it foreseen? |
|----|---|--|--|---|---------------------------------|---------------------|--|--|
| HR | One view per attachment | No limit | 6 | JPG/JPEG/GIF/ PNG/BMP | Max 40 MB | 5 MB | Max 600 dpi | Yes; "e-Prijava" is an electronic service enabling filing an application for the registration of industrial property rights via the Internet |
| HU | One view per attachment | 50 | 100 (technical limit- max 250 Kbyte each) | JPG/PNG (Government Decree No. 147/2007 on the detailed rules concerning electronic filing...) | 100 views x max. 250 Kbyte/view | 250 Kbyte | Current technical limits: 100 views maximum and max.250 Kbyte each | Only those clients can send E-filing who has official E-signature via "Ügyfélkapu" (Clientgate) or via the Official website of HIPO: https://ugyintezes.hipo.gov.hu/eBej2/Step1Case6.page |
| IE | One view per attachment | 100 | 7 | JPEG | No Limit | 4 MB | 800 x 600 pixels 300 dpi | E-filing was introduced on 11/12/2015 |
| IS | Electronic filing is not available yet but is foreseen - 2015 | | | | | | | |

| | Maximum number of views per Attachment | Maximum number of designs uploaded per application | Maximum number of views uploaded per design | File Format Type | Total Application Size Limit | Size Limit per View | Minimum and Maximum resolution (dpi) | Does your office have an E-Filing system? If so, which one? If not, is it foreseen? |
|----|--|--|---|---|------------------------------|---------------------|--------------------------------------|---|
| IT | One view per attachment | No limit | No limit | PDF | Max 10 MB file size | No limit | 300 dpi | E- filing available (https://servizionline.uibm.gov.it) |
| LT | One view per attachment | 100 | No limit | JPG,GIF,PNG | No limit | 2 MB | No Limit | Yes, CF SP FO |
| LV | One view per attachment | No limit | No limit | JPEG, JPG, BMP, TIFF, TIF, PNG | No limit | 15 MB | Min 300 dpi | EUIPO CF SP DS e-filing |
| MT | One view per attachment | 1 | 7 | JPG,PNG,GIF | N/A | No checks | N/A | http://ips.gov.mt/welcome/ |
| NO | No | No | No | No limitations, just recommendations | | 10 MB | | www.altinn.no/en |
| PL | No limit | 10 or unlimited in case of set | No limit | TIFF, TIF, JPG, GIF, doc, docx, rtf, pdf, txt | No limit | No limit | No regulation | Yes epuap.gov.pl |
| PT | One view per attachment | 100 | 7 | JPG/TIFF/PDF - A4 size form | | 10 MB | Min 300 dpi and Max 600 dpi | YES |

| | Maximum number of views per Attachment | Maximum number of designs uploaded per application | Maximum number of views uploaded per design | File Format Type | Total Application Size Limit | Size Limit per View | Minimum and Maximum resolution (dpi) | Does your office have an E-Filing system? If so, which one? If not, is it foreseen? |
|------|---|--|---|------------------|------------------------------|---------------------|--------------------------------------|---|
| RO | One view per attachment | 100 | No limit | GIF | No limit | 2 MB | Max 600 dpi | Sep-14 |
| SE | One view per attachment | No limit | No limit | JPG, PNG, GIF | No limit | 50Mb | 300 dpi | E-filing from CFO and adapted for PRV |
| SI | One attachment per view | 10 | 6 | JPG | Max 130 MB | 2 MB | Max 300 dpi Min is not limited | YES |
| SK | Electronic filing is not available yet but is foreseen - 2016 | | | | | | | |
| TR | One view per attachment | No limit | No limit | JPG | No Limit | 1 MB | Only 300dpi | Yes. A special program which is developed for design applications. |
| UK | Max. 7 views | | 7 | | | | | |
| WIPO | Several views are possible | 100 | No limit | JPG, TIFF | No Limit | | 300 dpi | Efiling |

| | Maximum number of views per Attachment | Maximum number of designs uploaded per application | Maximum number of views uploaded per design | File Format Type | Total Application Size Limit | Size Limit per View | Minimum and Maximum resolution (dpi) | Does your office have an E-Filing system? If so, which one? If not, is it foreseen? |
|-------|--|--|---|------------------|------------------------------|---------------------|--|---|
| EUIPO | One view per attachment | No limit | 7 | JPG | No limit | 5 MB | Printing resolution: min 96, max 300 DPI | E-Filing |

www.tmdn.org

Convergence



European Union Intellectual Property Office

Avenida de Europa 4,
E-03008 Alicante, Spain
Tel +34 96 513 9100
Fax +34 96 513 1344
information@euipo.europa.eu
www.euipo.europa.eu